

PRODUCT INFORMATION

MODEL: PT380

Phase Perfect® Digital Phase Converters represent the ultimate technology for converting single-phase electrical power to three-phase electrical power. In fact, the three-phase power produced by Phase Perfect® is often superior in power quality to utility supplied three-phase.

Phase Perfect® utilizes the latest advances in solid state power switching technology. Unlike rotary phase converters, it does not rely on a motor to generate a voltage. Proprietary software controls power switching devices that generate three-phase power with much more precision and efficiency. Its patented design makes it unlike any other phase converter.



POWER QUALITY

Phase Perfect® produces true sinusoidal three-phase output voltages balanced to within 1% under all load conditions. Because the output voltage is a sine wave with very low harmonic distortion, all types of three-phase equipment can be safely powered. Input current is true sinusoidal, near unity (.99) power factor and does not produce harmonics which can pollute the power grid. Phase Perfect's PT Series has 3-stage EMI filtering with EMI gasketed enclosures available when electromagnetic interference is an issue.

REGENERATIVE POWER CAPABILITY

Phase Perfect converters handle regenerative power by passing clean, balanced power back onto the single-phase line when three-phase loads are in a generating mode. Most other power switching converters waste regenerative power by burning it up with braking resistors. Putting regenerative power back onto the line saves electrical power and even allows Phase Perfect to operate continuously as a three-phase to single-phase converter.

VERSATILITY

Phase Perfect® can safely power virtually any three-phase application within its rated capacity. It can power resistive and capacitive loads as well as motor or inductive loads. Its power quality makes it ideal for powering demanding loads such as CNC machine equipment, submersible pumps and other voltage sensitive applications. The Phase Perfect PT Series can operate with either 50 or 60Hz input.

EASY INSTALLATION AND OPERATION

Phase Perfect® is available with built-in contactor and adjustable solid state overload relay, which allows it to function as a motor starter for most single-motor applications. It also has a control circuit and terminals, which allows an external switch to control both the converter and the load. Installation is straightforward and simple and can usually be accomplished in minutes with a minimum of additional equipment required.

ECONOMY

Utility three-phase service can cost thousands of dollars to install, even when three-phase lines are nearby. Phase Perfect® is an affordable alternative that provides better phase balance than most utilities will specify for their service. It also protects three-phase equipment from damage due to under-voltage, over-voltage and single-phasing that can occur with AC mains power. Phase Perfect® is rugged, reliable and typically 97% efficient.

Model PT380

FEATURES

- Balanced three-phase voltages
- High efficiency
- Electronic power factor correction
- High momentary overload current capacity
- Automatic brownout and over-voltage protection
- Fault protection and overload protection
- Built-in motor starter capability
- Clean power fed back to utility grid from three-phase generating loads
- 50 or 60 Hz input frequency allows operation anywhere in the world

SPECIFICATIONS

Specifications are subject to change without notice.

SINGLE-PHASE POWER

1-phase current characteristics	Sinusoidal, 2% total harmonic distortion
Power factor	Near unity, all load conditions (.99)
Voltage	187 – 260 volts
Recommended maximum 1-phase circuit breaker rating	175-200 amps

THREE-PHASE POWER

Rated HP	30
Rated Current Output	80
3-phase power characteristics	Sinusoidal, 3% total harmonic distortion
Phase-to-phase voltage balance	Better than 1% (NEMA MG1 standard for voltage unbalance)
Voltage	Equal to single-phase input voltage – 187-260 volts
Maximum 3-phase current, steady state	96 amps
Overload current, 4 seconds	400 amps

PROTECTIVE FUNCTIONS

Under-voltage	Automatic shutdown <187 V, restart when >199 V
Over-voltage	Automatic shutdown >260 V, restart when <260 V
Internal temperature sensor	Automatic shutdown if overheated

GENERAL

Efficiency	97% typical
Operating temperature range	-10 – 40 C
Storage temperature	-20 – 60 C
Weight	180 lb.
Enclosure	Powder coated steel, Type 1 indoor or Type 3R rain proof, and powder coated Al with EMI gasketing
Dimensions (H x W x D)	Wall mount
Type 1 indoor	31 x 24 x 13 in.
Type 3R rainproof	35 x 24 x 13 in.

OPTIONS

3-stage EMI filtering with EMI gasketed enclosure
Plasma display with 36 character text for status indicators
Built-in motor starter for controlling single motor loads

THE INFORMATION CONTAINED IN THIS DRAWING IS THE SOLE PROPERTY OF PHASE TECHNOLOGIES. ANY REPRODUCTION IN PART OR WHOLE WITHOUT THE WRITTEN PERMISSION OF Phase Technologies LLC IS PROHIBITED.

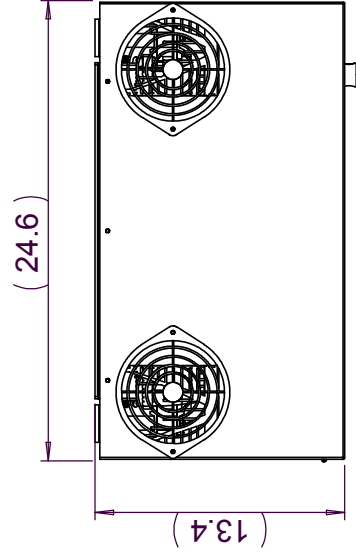
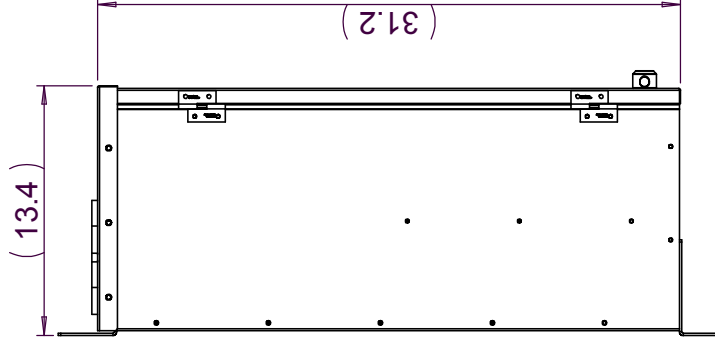
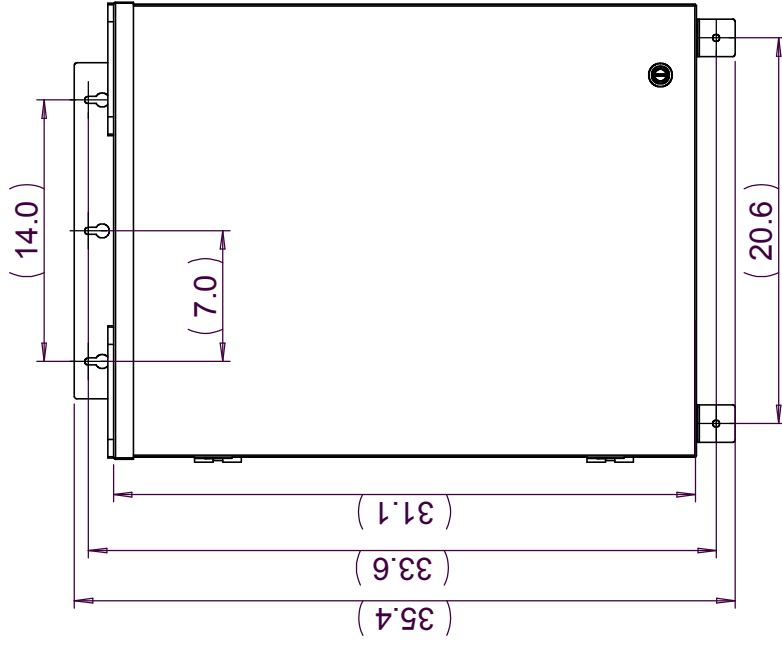

Phase Technologies LLC

PT380
V1.2
Indoor

Date 11/2009

SHEET

OF

THE INFORMATION CONTAINED IN THIS DRAWING IS THE SOLE PROPERTY OF PHASE TECHNOLOGIES. ANY REPRODUCTION IN PART OR WHOLE WITHOUT THE WRITTEN PERMISSION OF Phase Technologies LLC IS PROHIBITED.

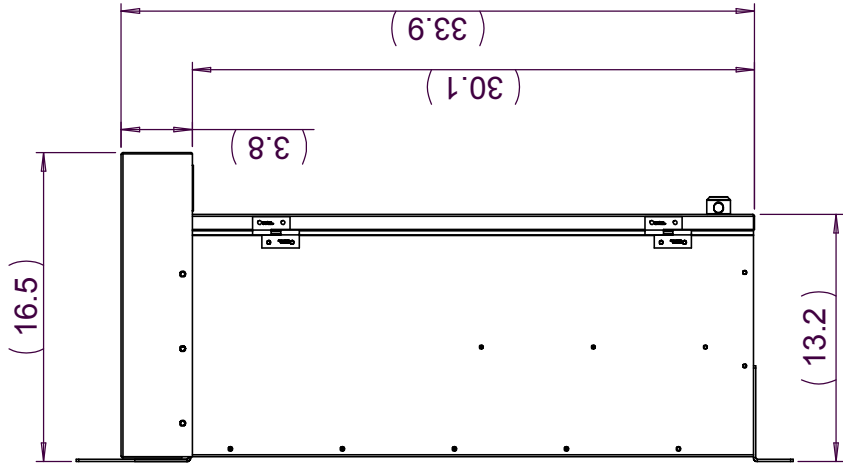
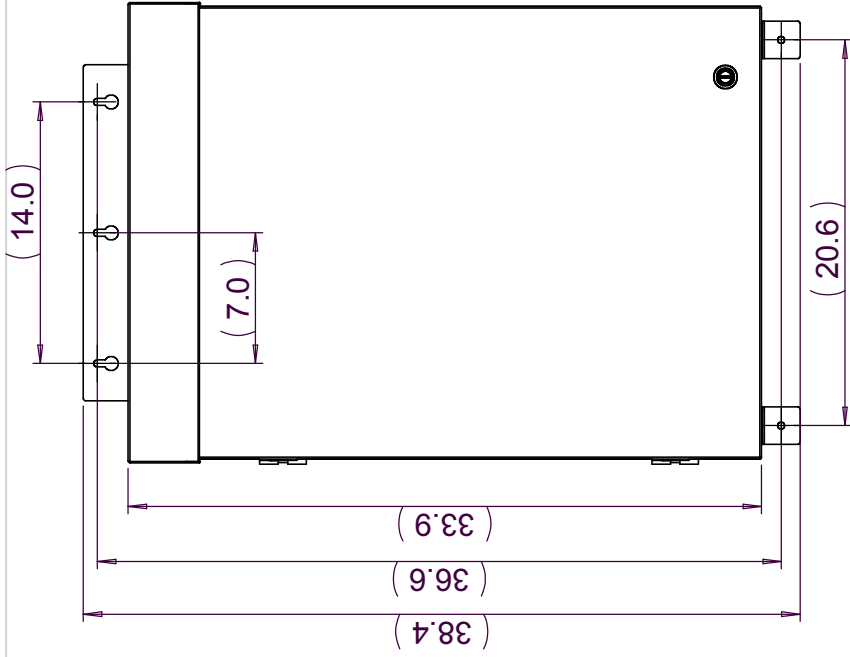

Phase Technologies LLC

PT380
V1.2
Outdoor

Date

11/2009

SHEET

OF